

## MOVABLE AIR SOLAR COLLECTOR AND ITS EFFICIENCY

Aigars Lauva, Aivars Āboltniš, Jānis Palabinskis, Nadežda Karpova Sadigova  
Latvia University of Agriculture  
Aigars.Lauva@inbox.lv, Aivars.Aboltins@inbox.lv, Janis.Palabinskis@llu.lv,  
Nadezda.Karpova@llu.lv

**Abstract.** Implementing the guidelines of the Latvian National Programme for Energy in the field of alternative energy, intensive research shall be carried on regarding the use of solar energy, as it can be successfully used not only for the purposes of water heating and production of electrical energy, but also for air warming. The amount of heat necessary for the drying of rough forage and grain drying by active aeration in June, July and August can be obtained using solar radiation. The Latvian Guidelines for the Energy Development 2006 – 2016 state that the solar radiance in Latvia is of quite low intensity. The total amount of solar energy is 1109 kWh m<sup>-2</sup> per year. The period of usage of the solar thermal energy is beginning from the last decade of April, when the intensity of radiation is 120 kWh m<sup>-2</sup>, until the first decade of September. Within this period (approximately 1800 hours), it is possible to use the solar thermal energy by placing solar collectors. The usage of solar collectors for in drying of agricultural production is topical from the viewpoint of decreasing the consumption of energy used for the drying, as electrical energy and fossil energy resources become more expensive and tend to run out. In the processes that concern drying of agricultural production, efficiently enough solar radiation energy can be used. Due to this reason researching continues and expands in the field of usage of solar energy for the processes of drying and heating. The efficiency factor of the existing solar collectors is not high, but they are of simple design and cheap for production and exploitation. By improving the design of the solar collectors and choosing modern materials that absorb the solar radiation energy, it is possible the decrease the efficiency factor of solar collectors and decrease the production costs. In the scientific laboratory of grain drying and storage of Latvia University of Agriculture, a pilot device movable folding solar collector pilot device suitable for Latvia has been developed and constructed. Within the article, the movable folding solar collector is described, which has been constructed as a solar collector of module types for being able to move and unfold it in the place of work. The solar collector serves as an experimental prototype, as well as simultaneously as a ground for comparative researches in solar absorbent air. The solar collector serves as an experimental prototype and simultaneously also as a carrying surface for comparative researches in solar absorbent air. In the researches, the roof coverings available in Latvia and their suitability for construction of solar collectors will be compared.

**Key words:** movable air solar collector, heat transmission, solar radiation, drying at low temperatures.

### Introduction

During the research, a folding movable air solar collector devise has been developed. The usage of solar collectors for drying of agricultural production is topical from the viewpoint of decreasing the consumption of energy used for the drying, as electrical energy and fossil energy resources become more expensive and tend to run out.

In the processes that concern drying of agricultural production, efficiently enough solar radiation energy can be used. Due to this reason researching continues about the usage of solar energy for the processes of drying and heating.

The researches on solar collectors directly account for the increase in the usage of solar energy. The amount of heat necessary for the drying of rough forage and grain drying by active aeration in July - September can be obtained by using solar radiation. In the latitude of Latvia, the average solar radiation capacity on a horizontal surface in the above mentioned period of time at noon is more than 600 W m<sup>-2</sup>. Air heated in this way is not toxic and electrically neutral.

The efficiency factor of the existing solar collectors is not high, but they are of simple design and cheap for production and exploitation.

By improving the design of the solar collectors and choosing modern materials that absorb the solar radiation energy, it is possible the decrease the efficiency factor of solar collectors and decrease the production costs.

The idea and the technical solution solar collectors is based on the analysis of previous researches and practical experience. The former solar collectors were designed, using stationery constructions. Such devises required huge capital investments for construction and were expensive for exploitation.

## Materials and Methods

The technical solution of the pilot Project of the concerned folding movable air solar collector is based on the principle of complete mobility and comfort for service (Fig. 1).

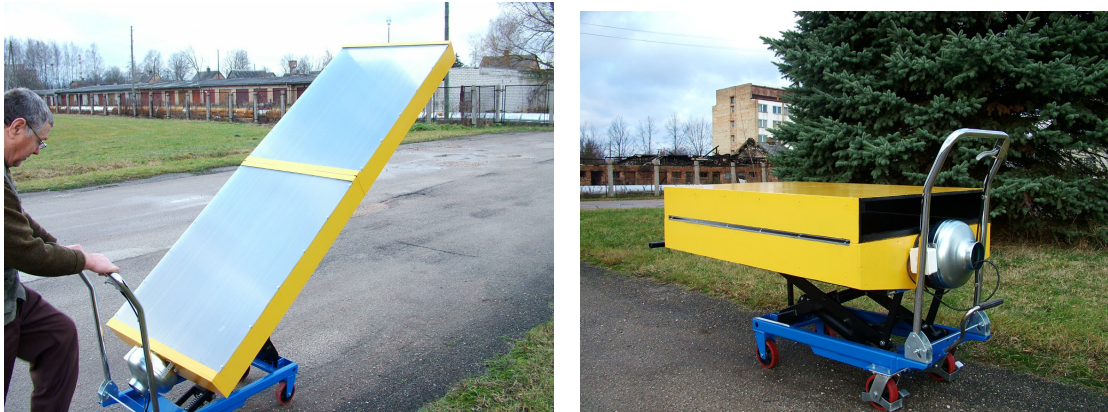

Fig. 1. Movable air solar collector in operating condition and transportation

The concerned solar collector is a movable device that, if necessary, can be easily moved from one object of aeration to another. It requires one person for service.

The solar collector is planned for small grain amount or bin aeration, as well as for controlling of the idea and technical solution and testing in laboratories. When the project is implemented, the movable air solar collector will be ready for practical use. The technical solution of the concerned solar collector is based on 3 basic elements – trolley with hydraulically lifted platform in the angle from 0 to 40 °, folding solar collector and a fan with power supply and folding collector.

Industrially produced hydraulically lifted platform trolley TF 30 with lifting power 300 kg and platform size 500 x 850 x 50 mm has been used as the carrying element. The trolley has four wheels and the body mass 77 kg. For ensuring of the solar collector slope, the trolley lifting mechanism was modified so that lifting the solar collector by the help of a hydraulic cylinder, direct slope regulation against the horizontal plane from 0 to 40 ° is obtained.

In the body of the trolley, a telescopically extendible solar collector support is built, that serves as a carrying element for the unfolded solar collector and can simultaneously also serve as a handle used to move the movable air solar collector.

The modules of the solar collectors, which are two, sizes of which are 800 x 1200 x 130 mm, correspond to one of the sizes of Europalette. The module is constructed from 12 mm moisture resistant plywood and the inner surface has been covered with a black mat colour for a more efficient perception of solar radiance. The modules have been fastened with hinges, that serve for unfolding and folding of the modules. Transparent 6 mm thick leaf cell polycarbonate, that is mechanically and atmospherically resistant, as well as sufficiently effective from the viewpoint of thermotechnics, has been used as an element absorbing solar energy.

One of the modules is stationary fastened to the trolley platform, the other – to the first module with hinges. In the module fastened to the trolley, a fan DOSPEL WK 100 is installed with the capacity  $Q = 290 \text{ m}^3 \text{ h}^{-1}$  and the consumed power  $N = 58 \text{ W}$ . For the discharge of the heated air in the desirable aerated material, a flexible collector is used, that is fastened to the exhaust manifold by means of clamps.

## Results and Discussion

In order to research in the efficiency of solar collector, in September of 2007 experiments were carried on to determine the degree of air heating in the collector depending on the solar radiation (Fig. 2.).

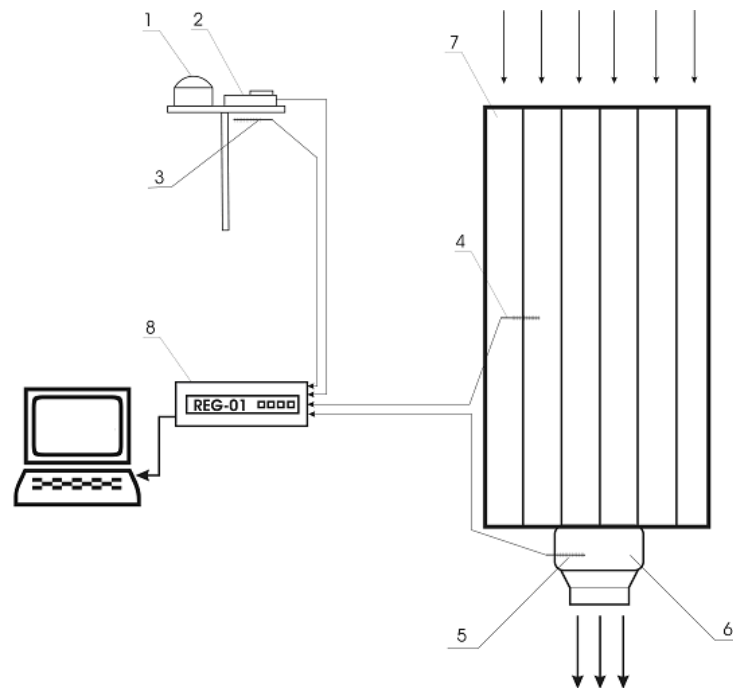

Fig. 2. **Experimental device for researches in movable air solar collector:** 1 – solar radiation meter (pyranometer); 2 – solar lightning measurer; 3 – atmosphere air temperature sensor; 4, 5 – heated air temperature sensors; 6 – fan; 7 – solar collector; 8 – measurement and registration device REG.

The experimental data are registered by the device of measurement and registration of the temperature, radiation and lightning REG – 01. The device is equipped with 16 temperature indicators and sensors of solar radiation and lightning measurement. The time for reading the data may be programmed beginning from 1 minute to 99 minutes. The registered data remains in the memory of REG (space for 16384 entries) and, if necessary, can be sent to a computer for archiving and future processing. For the evaluation and analysis of the results, software REG – 01 has been developed for sending the registered data to a computer and processing. The information is stored in a table and, if necessary, can be reflected also graphically.

The measurements of temperature included determination of the inlet air, the outlet air, as well as the temperature in the middle of the collector, that is, between the first and the second section. The measurements were performed once in a minute.

The experimental data of September 7 (within the time period of 12.00 to 16.00) are indicated in Fig. 3, but the data of September 12 (within the time period of 11.30 to 15.30) are indicated in Fig. 4.

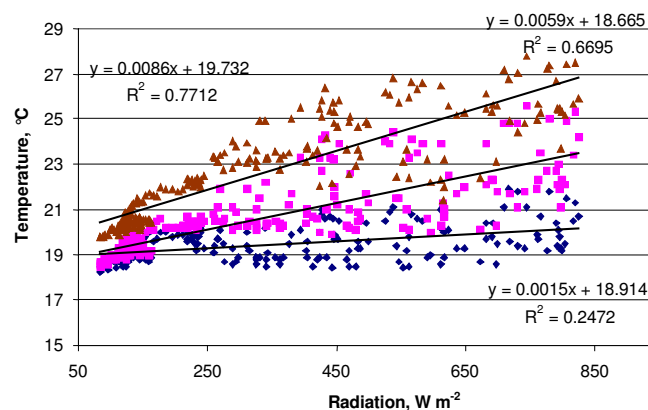

Fig. 3. **Subjection of air temperatures to the intensity of solar radiation (September 7, 2007):**

▲ – atmospheric; ■ – in the middle of the collector; ◆ – outlet

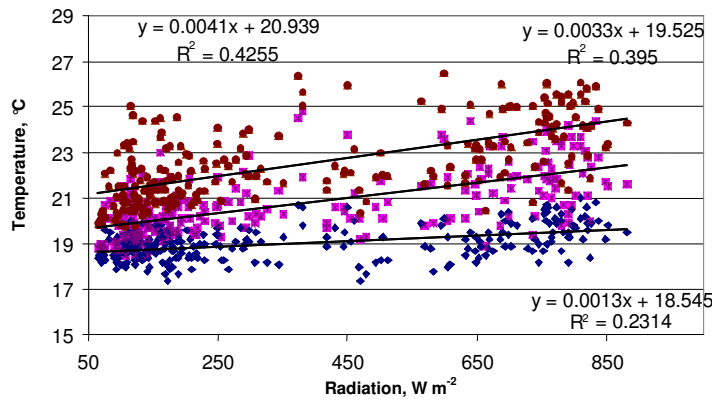

Fig. 4. Subjection of air temperatures to the intensity of solar radiation (September 12, 2007):

▲ – atmospheric; ■ – in the middle of the collector; ◆ – outlet

The efficiency of operation of the solar collector depends on the degree of air heating, that is, the increase of the temperature passing through the collector. The increase in the temperature in the middle of the collector and leaving it is reflected in Fig. 5 – 7.

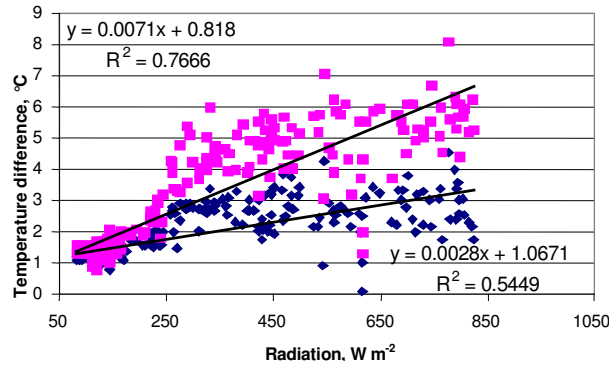

Fig. 5. Increase in the temperature depending on the solar radiation (September 7, 2007)

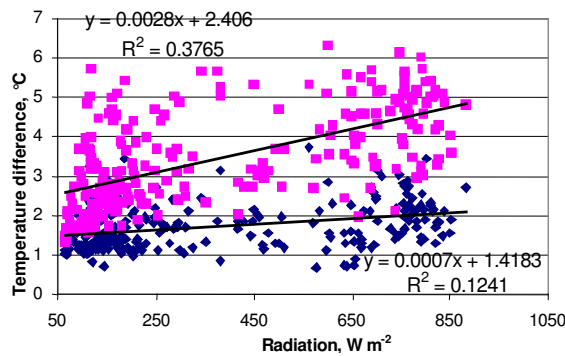

Fig. 6. Increase in the temperature depending on the solar radiation (September 12, 2007)

In the experimental results, it can be seen that at an average capacity of solar radiation on the horizontal surface ( $> 600 \text{ W m}^{-2}$ ) the average air heating degree is 6 degrees. Besides, quite a high correlation can be observed between the solar radiation intensity and the degree of heating (more than 0.6).

It should be considered that solar radiation substantially changes when a cloud covers the sun, but the collector itself has much more inertia and it does not cause serious changes in the operation of the collector.

This inertia can be observed also in the beginning of the operation of the collector (Fig. 8, 9). The experiment was done in September 25, in the time period from 13.15 to 16.15.

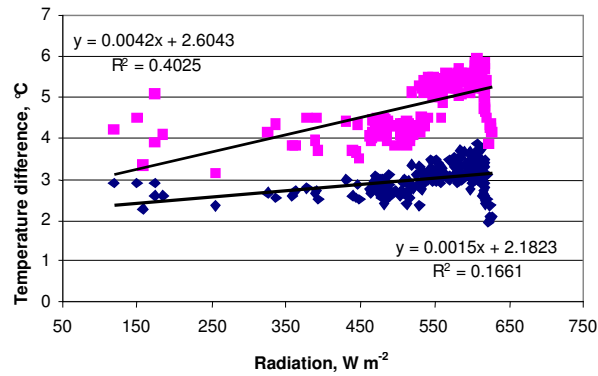

Fig. 7. Increase in the temperature depending on the solar radiation (September 25, 2007)

It can be seen that only after a long enough period of time the collector can work at its optimal productivity, as the sorbent has not yet properly absorbed the solar energy and heated for being able to return its accumulated energy to the air flowing through.

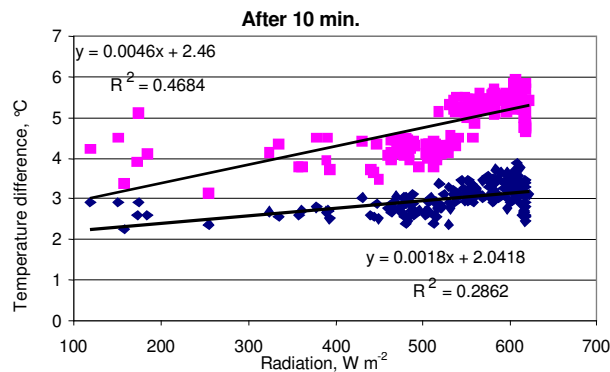

Fig. 8. Air heating degrees depending on the solar radiation 10 minutes after the beginning of operation of the collector (September 25, 2007)

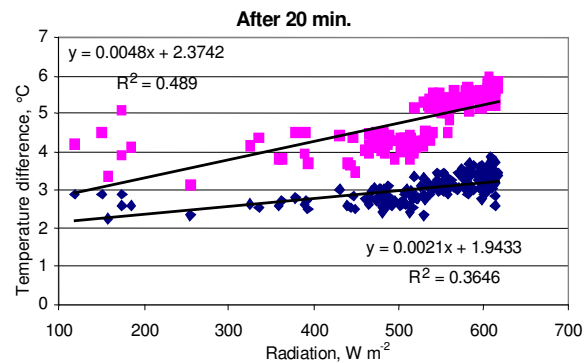

Fig. 9. Air heating degrees depending on the solar radiation 20 minutes after the beginning of operation of the collector (September 25, 2007)

As it can be seen, the relation of the solar radiation and the heated air becomes closer, as the process becomes more stationary. We should not forget that during four hours the sun angle essentially changes against the surface of the collector, causing dispersion in the result.

As the capacity of the electric motor of the collector  $Q = 290 \text{ m}^3 \text{ h}^{-1}$ , the experiment lasts for 4 hours, and we assume the heating degree for air in the average to be five degrees, the necessary amount of heat is 7549 kJ [1]. On the other hand, the energy consumed by the electric motor, which is necessary for ensuring the airflow in the collector for 4 hours, is approximately 835 kJ (calculated for the particular fan model, which is used in the module of the collector). This proves the high efficiency of the collector, as well as usefulness.

**Conclusions**

1. In the project, a technical solution has been implemented for a movable air solar collector for the drying of different plant products by air heated using solar energy.
2. A movable air solar collector with the efficient solar surface area 1.75 m<sup>2</sup> and air through-flow cross-section area 0.1 m<sup>2</sup> has been produced.
3. The design of the solar collector ensures its long-term and safe exploitation, and it requires one person for service.
4. Folding and unfolding of the solar collector can be done in 5 minutes, excluding the time of its moving.
5. The device will serve as an object of experimental research in the field of improvement of solar collectors.
6. The collector obtains from the sun almost 10 times more energy than the fan consumes.
7. The solar collector may serve also as a prototype for more powerful movable air solar collectors with power vehicle traction.

**References**

1. 1. Kuchling H. (1980) Physik Veb Fachbuchverlag, Leipzig, 519.pp.